



**HANDLEIDING / MANUAL /
MODE D'EMPLOI / ANLEITUNG
SLEUTELSCHAKELAARS /
KEY SWITCHES /
INTERRUPTEURS À CLÉ /
SCHLÜSSELSCHALTER**



MODELLEN / MODELS / MODÈLES / MODELLE

SM1T, SM2T, SM1R, SM2R, FM1T, FM2T, FM1R, FM2R
 SM1TSL, SM2TSL, SM1RSL, SM2RSL, FM1TSL, FM2TSL, FM1RSL, FM2RSL



SPECIFICATIES / SPECIFICATIONS / CARACTERISTIQUES / TECHNISCHE DATEN

IP55, 5A 300V AC / 5A 48V DC

UITLEG ARTIKELNUMMERS / EXPLANATION OF ARTICLE NUMBERS /

EXPLICATION DES NUMEROS D'ARTICLE / ERLÄUTERUNG DER ARTIKELNUMMERN /

SM = opbouwuitvoering / surface mount / en applique / Aufputz

FM = inbouwuitvoering / flush mount / encastré / Unterputz

1T = pulscontact naar één zijde (maak- of verbreekcontact)
 one way momentary (normally open or normally closed)
 impuls un côté (normalement ouvert ou normalement fermé)
 Einseitiger Tast (Schließer oder Öffner)

2T = pulscontact naar twee zijden (maakcontact)
 two way momentary (normally open)
 impuls deux côtés. (normalement ouvert)
 Zweiseitiger Tast (Schließer)

1R = continucontact naar één zijde (maak- of verbreekcontact)
 one way maintained (normally open or normally closed)
 un de contact fixe (normalement ouvert ou normalement fermé)
 Einseitiger Rast (Schließer oder Öffner)

2R = continucontact naar twee zijde (maakcontact)
 two way maintained (normally open)
 deux de contact fixe (normalement ouvert)
 Zweiseitiger Rast (Schließer)

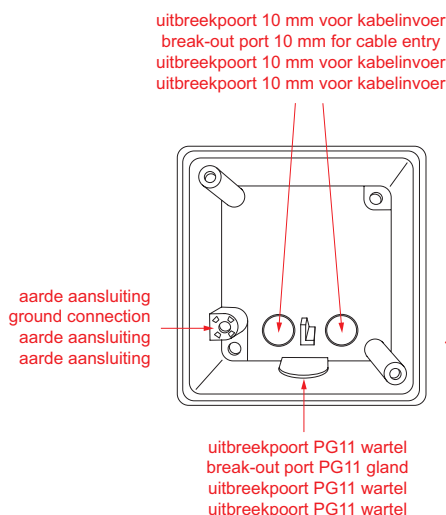

SCHAKELAARS / SWITCHES / COMMUTATEURS / SCHALTER

Standaard schakelaars / standard switches / commutateurs standard / Standardschalter

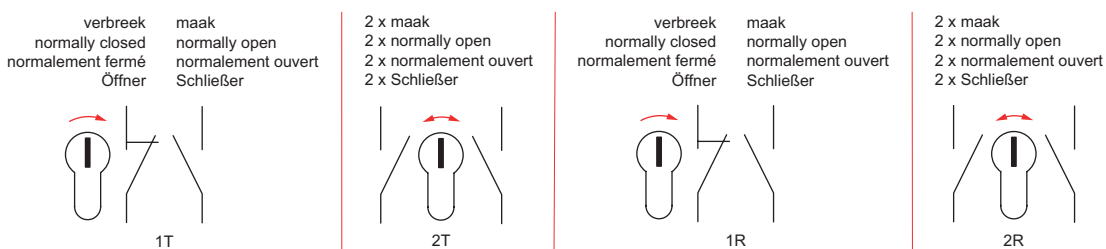

Optionele schakelaars / optional switches / commutateurs optionnel / optionaler Schalter

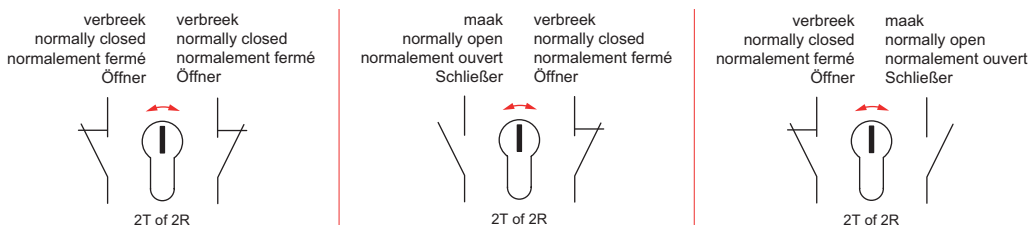

LED-SABOTAGESCHAKELAAR PCB / LED-TAMPER PCB /
 LED-CONTACT ANTI-SABOTAGE PCB / LED-ALARMKONTAKT PCB



TAMP: 3A / 30VDC
 LED: 12-24V DC / max. 20mA





INSTALLATIE



Zorg bij de opbouw uitvoering dat de behuizing stevig op de muur wordt gemonteerd.

Zorg bij de inbouw uitvoering dat de behuizing stevig in de muur wordt gemonteerd en zorg daarbij dat de voorzijde van de sleutelschakelaar gelijk met de muur ligt.

Voer de aansluitkabel via het daarvoor bestemde gat (uitbreekpoort aan de achterzijde of aan de onderzijde van de behuizing) in de behuizing.

Haal de schakelaar(s) (zie  in onderstaande tekening) uit de behuizing, sluit ze aan en plaats ze weer terug.
Bij de 1T en 1R modellen dient men 1 schakelaar aan te sluiten, bij de 2T en 2R modellen 2 schakelaars.
Bij de 1T en 2T modellen dienen de  pijltjes op het draaielement en het basiselement tegenover elkaar te staan volgens tekening **A**.
Bij de 1R en 2R modellen dienen de  pijltjes op het draaielement en het basiselement tegenover elkaar te staan volgens tekening **B**.

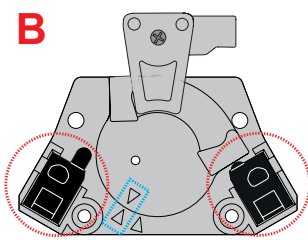
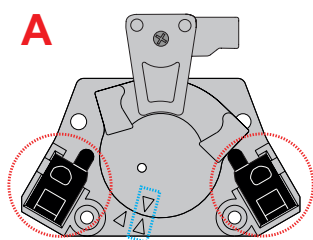

S29M
Zwarte kleur voor NO schakelaar (maakcontact)
5A 300V AC / 5A 48V DC



S29V
Bruine kleur voor NC schakelaar (verbreekcontact)
5A 300V AC / 5A 48V DC

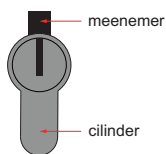

Zorg ervoor dat de meenemer van de europrofiel cilinder met de sleutel uitgenomen in een 12 uur positie staat. Monteer de europrofielcilinder met de meegeleverde schroef aan het voorste gedeelte van de sleutelschakelaar.



Zet de meenemer van de europrofiel cilinder met de sleutel op 1 uur.

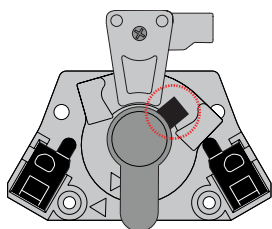

Plaats het voorste gedeelte van de sleutelschakelaar, met de meenemer van de europrofiel cilinder op 1 uur, in de behuizing (zie  in tekening links). Zet deze vast met de 2 meegeleverde schroeven.

Plaats de rubberen afdichting om de cilinder.

Schroef het afdekplaatje op de sleutelschakelaar.

De 2 stuks diagonaal voorgeboorde montagegaten in behuizing zijn 5,5 mm.



Gebruik trekcontasting voor kabel (wartel).



INSTALLATION



For the surface-mounted version, ensure that the housing is mounted firmly on the wall.

In the case of the flush-mounted version, ensure that the housing is securely mounted in the wall, ensuring that the front of the key switch is flush with the wall.

Feed the connecting cable into the housing through the hole provided (breakout port at the rear or at the bottom of the housing).

Remove the switch(es) (shown  in the drawing below) from the housing, connect and replace them.

For the 1T and 1R models, 1 switch should be connected, for the 2T and 2R models 2 switches.

For 1T and 2T models, the  arrows on the rotating element and the base element should be opposite each other according to drawing **A**.

For 1R and 2R models, the  arrows on the rotating element and the base element should be opposite each other according to drawing **B**.

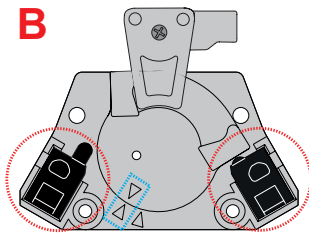
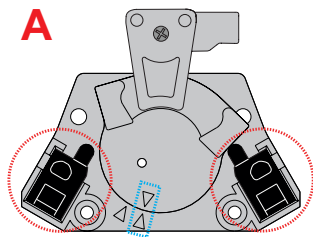

S29M
 Black color for NO switch (Normally Open contact)
 5A 300V AC / 5A 48V DC



S29V
 Brown color for NC switch (Normally Closed contact)
 5A 300V AC / 5A 48V DC

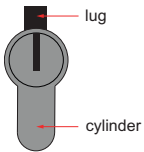

With the key removed, ensure that the lug of the europrofile cylinder is in a 12 o'clock position. Fit the europrofile cylinder to the front part of the key switch with the screw provided.



Set the lug of the europrofile cylinder with the key to 1 o'clock.

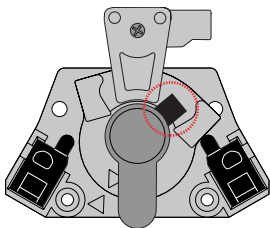

Insert the front part of the key switch, with the lug of the europrofile cylinder at 1 o'clock, into the housing (see  in drawing on the left). Secure it with the 2 screws provided.

Place the rubber seal around the cylinder.

Screw the cover plate onto the key switch.

The 2 pieces of diagonally pre-drilled mounting holes in housing are 5.5 mm.



Use strain relief for cable (cable gland).



INSTALLATION



For the surface-mounted version, ensure that the housing is mounted firmly on the wall.

In the case of the flush-mounted version, ensure that the housing is securely mounted in the wall, ensuring that the front of the key switch is flush with the wall.

Feed the connecting cable into the housing through the hole provided (breakout port at the rear or at the bottom of the housing).

Remove the switch(es) (shown  in the drawing below) from the housing, connect and replace them.

For the 1T and 1R models, 1 switch should be connected, for the 2T and 2R models 2 switches.

For 1T and 2T models, the  arrows on the rotating element and the base element should be opposite each other according to drawing **A**.

For 1R and 2R models, the  arrows on the rotating element and the base element should be opposite each other according to drawing **B**.

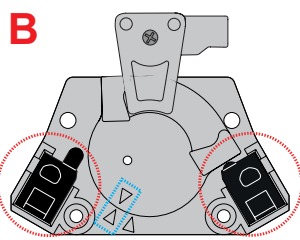
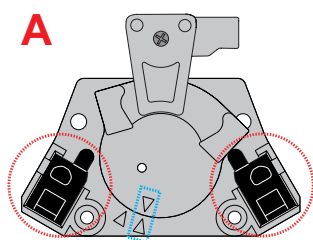

S29M
 Black color for NO switch (Normally Open contact)
 5A 300V AC / 5A 48V DC



S29V
 Brown color for NC switch (Normally Closed contact)
 5A 300V AC / 5A 48V DC

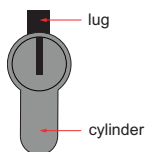

With the key removed, ensure that the lug of the europrofile cylinder is in a 12 o'clock position. Fit the europrofile cylinder to the front part of the key switch with the screw provided.



Set the lug of the europrofile cylinder with the key to 1 o'clock.

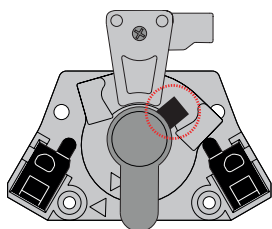

Insert the front part of the key switch, with the lug of the europrofile cylinder at 1 o'clock, into the housing (see  in drawing on the left). Secure it with the 2 screws provided.

Place the rubber seal around the cylinder.

Screw the cover plate onto the key switch.

The 2 pieces of diagonally pre-drilled mounting holes in housing are 5.5 mm.

 Use strain relief for cable (cable gland).



INSTALLATION

For the surface-mounted version, ensure that the housing is mounted firmly on the wall.





In the case of the flush-mounted version, ensure that the housing is securely mounted in the wall, ensuring that the front of the key switch is flush with the wall.

Feed the connecting cable into the housing through the hole provided (breakout port at the rear or at the bottom of the housing).

Remove the switch(es) (shown  in the drawing below) from the housing, connect and replace them.

For the 1T and 1R models, 1 switch should be connected, for the 2T and 2R models 2 switches.

For 1T and 2T models, the  arrows on the rotating element and the base element should be opposite each other according to drawing **A**.

For 1R and 2R models, the  arrows on the rotating element and the base element should be opposite each other according to drawing **B**.

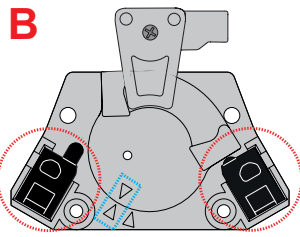
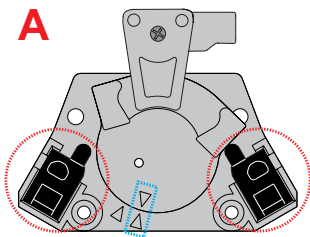

S29V
 Black color for NO switch (Normally Open contact)
 5A 300V AC / 5A 48V DC



S29V
 Brown color for NC switch (Normally Closed contact)
 5A 300V AC / 5A 48V DC

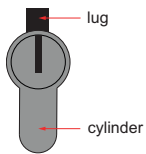

With the key removed, ensure that the lug of the europrofile cylinder is in a 12 o'clock position. Fit the europrofile cylinder to the front part of the key switch with the screw provided.



Set the lug of the europrofile cylinder with the key to 1 o'clock.

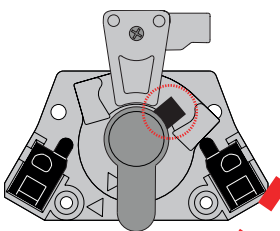

Insert the front part of the key switch, with the lug of the europrofile cylinder at 1 o'clock, into the housing (see  in drawing on the left). Secure it with the 2 screws provided.

Place the rubber seal around the cylinder.

Screw the cover plate onto the key switch.

The 2 pieces of diagonally pre-drilled mounting holes in housing are 5.5 mm.

 Use strain relief for cable (cable gland).



AFMETINGEN / DIMENSIONS / DIMENSIONS / ABMESSUNGEN

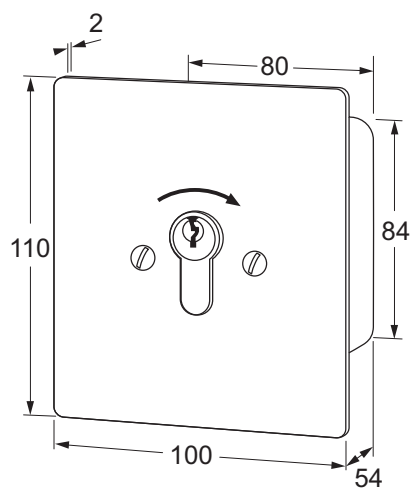
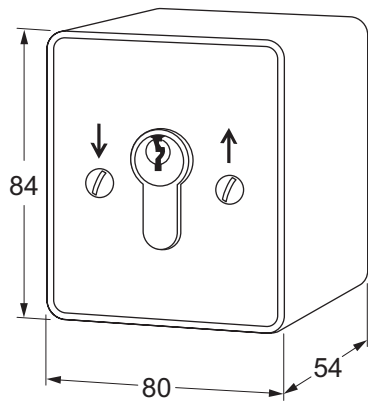

Maasland Groep B.V.
De Hoogjens 51-55a
4254 XV SLEEUWIJK
THE NETHERLANDS
T 088 500 2800
info@maaslandgroep.nl
www.maaslandgroep.nl



Maasland Hou Co., Ltd.
Floor 6, Block E,
Jinao Tech. & Ind. Park,
Dashuikeng,
Guanlan Town, Longhua
SHENZHEN, CHINA
info@maaslandhou.com
www.maaslandhou.com

Maasland Group Belgium B.V.
Eedverbondkaai 242, bus 41
9000 GENT
BELGIË
info@maaslandgroup.be
www.maaslandgroup.be

